



DCC010

Silicon Epitaxial Planar Type (Series Connection)

Ultrahigh-Speed Switching Diode

Features

- Ideally suited for use in hybrid ICs because of very small package.
- Fast switching speed.
- Small interterminal capacitance.

Package Dimensions

unit:mm
1147A

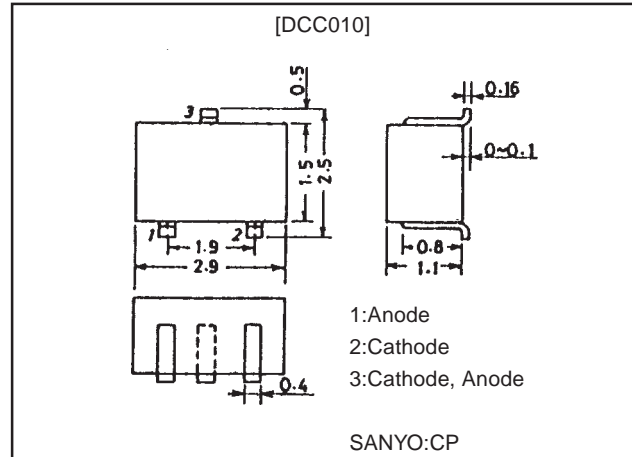

Specifications

Absolute Maximum Ratings at Ta = 25°C

Parameter	Symbol	Conditions	Ratings	Unit
Peak Reverse Voltage	V_{RM}		85	V
Reverse Voltage	V_R		80	V
Peak Forward Current	I_{FM}	Unit Rating	300	mA
			210	mA
Average Rectified Current	I_O	Unit Rating	100	mA
			70	mA
Surge Current (1 μ s)	I_{FSM}	Unit Rating	4	A
			2.8	A
Power Dissipation	P		200	mW
Junction Temperature	T_J		125	°C
Storage Temperature	T_{stg}		-55 to +125	°C

Electrical Characteristics at Ta = 25°C

Parameter	Symbol	Conditions	Ratings			Unit
			min	typ	max	
Forward Voltage	$V_F(1)$	$I_F=1mA$		0.60		V
	$V_F(2)$	$I_F=10mA$		0.72		V
	$V_F(3)$	$I_F=100mA$			1.20	V
Reverse Current	$I_R(1)$	$V_R=30V$			0.1	μA
	$I_R(2)$	$V_R=80V$			0.5	μA
Interterminal Capacitance	C	$V_R=0V, f=1MHz$			3.0	pF
Reverse Recovery Time	t_{rr}	$I_F=10mA, V_R=6V, R_L=50\Omega, I_{rr}=0.1I_{rp}$			4.0	ns

· Marking:W7

Reverse Recovery Time Test Circuit

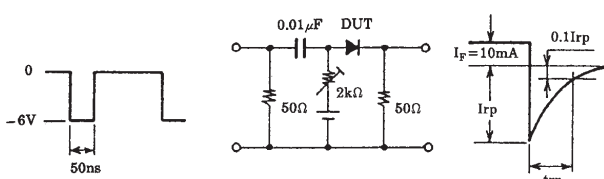

Electrical Connection

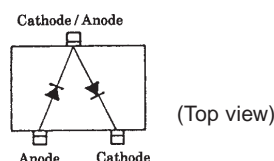

SANYO Electric Co.,Ltd. Semiconductor Business Headquarters

TOKYO OFFICE Tokyo Bldg., 1-10, 1 Chome, Ueno, Taito-ku, TOKYO, 110-8534 JAPAN

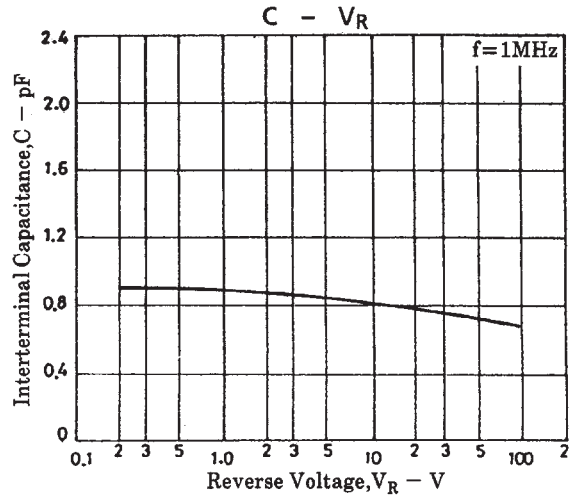
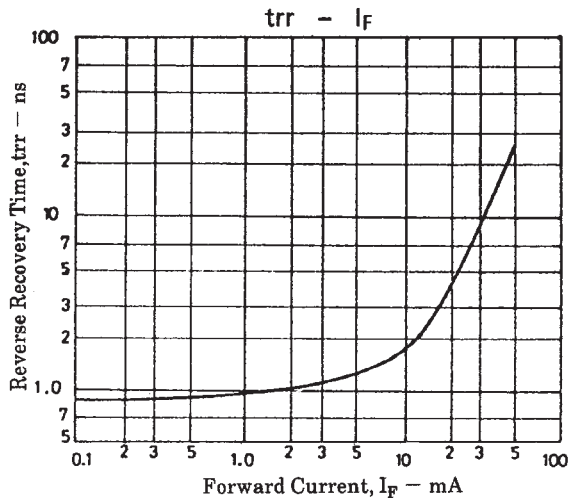
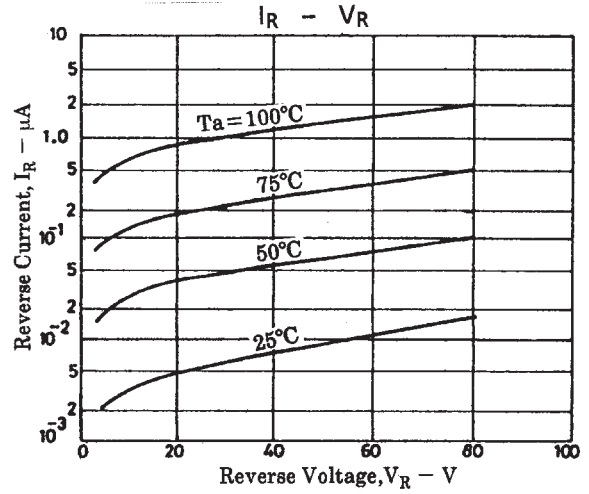
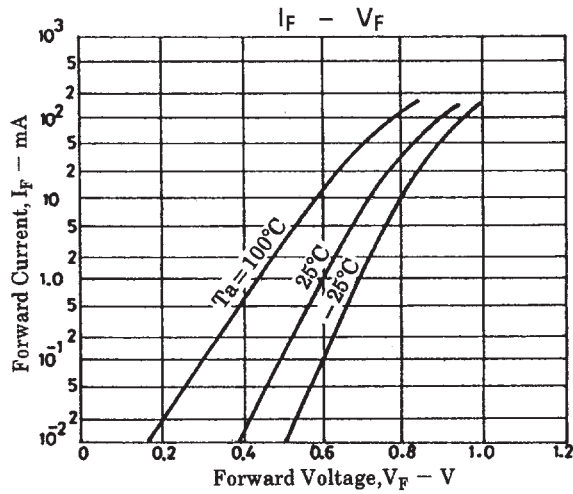

■ No products described or contained herein are intended for use in surgical implants, life-support systems, aerospace equipment, nuclear power control systems, vehicles, disaster/crime-prevention equipment and the like, the failure of which may directly or indirectly cause injury, death or property loss.

■ Anyone purchasing any products described or contained herein for an above-mentioned use shall:

- ① Accept full responsibility and indemnify and defend SANYO ELECTRIC CO., LTD., its affiliates, subsidiaries and distributors and all their officers and employees, jointly and severally, against any and all claims and litigation and all damages, cost and expenses associated with such use:
- ② Not impose any responsibility for any fault or negligence which may be cited in any such claim or litigation on SANYO ELECTRIC CO., LTD., its affiliates, subsidiaries and distributors or any of their officers and employees jointly or severally.

■ Information (including circuit diagrams and circuit parameters) herein is for example only; it is not guaranteed for volume production. SANYO believes information herein is accurate and reliable, but no guarantees are made or implied regarding its use or any infringements of intellectual property rights or other rights of third parties.

This catalog provides information as of March, 1998. Specifications and information herein are subject to change without notice.