

EVALUATION KIT  
AVAILABLE**MAXIM**

# 1A/2.7A, 1MHz, Step-Down Regulators with Synchronous Rectification and Internal Switches

## General Description

## Features

The MAX1742/MAX1842 constant-off-time, pulse-width-modulated (PWM) step-down DC-DC converters are ideal for use in 5V and 3.3V to low-voltage conversion necessary in notebook and subnotebook computers. These devices feature internal synchronous rectification for high efficiency and reduced component count. They require no external Schottky diode. The internal 90mΩ PMOS power switch and 70mΩ NMOS synchronous-rectifier switch easily deliver continuous load currents up to 1A. The MAX1742/MAX1842 produce a preset 2.5V, 1.8V, or 1.5V output voltage or an adjustable output from 1.1V to  $V_{IN}$ . They achieve efficiencies as high as 95%.

The MAX1742/MAX1842 use a unique current-mode, constant-off-time, PWM control scheme, which includes Idle Mode™ to maintain high efficiency during light-load operation. The programmable constant-off-time architecture sets switching frequencies up to 1MHz, allowing the user to optimize performance trade-offs between efficiency, output switching noise, component size, and cost. Both devices are designed for continuous output currents up to 1A. The MAX1742 uses a peak current limit of 1.3A (min) and is suitable for applications requiring small external component size and high efficiency. The MAX1842 has a higher current limit of 3.1A (min) and is intended for applications requiring an occasional burst of output current up to 2.7A. Both devices also feature an adjustable soft-start to limit surge currents during startup, a 100% duty cycle mode for low-dropout operation, and a low-power shutdown mode that disconnects the input from the output and reduces supply current below 1μA. The MAX1742/MAX1842 are available in 16-pin QSOP packages.

For similar devices that provide continuous output currents up to 2A and 3A, refer to the MAX1644 and MAX1623 data sheets.

## Applications

5V or 3.3V to Low-Voltage Conversion  
CPU I/O Ring  
Chipset Supplies  
Notebook and Subnotebook Computers

Pin Configuration appears at end of data sheet.

Idle Mode is a trademark of Maxim Integrated Products.

- ◆ ±1% Output Accuracy
- ◆ 95% Efficiency
- ◆ Internal PMOS and NMOS Switches
  - 90mΩ On-Resistance at  $V_{IN} = 4.5V$
  - 110mΩ On-Resistance at  $V_{IN} = 3V$
- ◆ Output Voltage
  - 2.5V, 1.8V, or 1.5V Pin Selectable
  - 1.1V to  $V_{IN}$  Adjustable
- ◆ 3V to 5.5V Input Voltage Range
- ◆ 600μA (max) Operating Supply Current
- ◆ <1μA Shutdown Supply Current
- ◆ Programmable Constant-Off-Time Operation
- ◆ 1MHz (max) Switching Frequency
- ◆ Idle-Mode Operation at Light Loads
- ◆ Thermal Shutdown
- ◆ Adjustable Soft-Start Inrush Current Limiting
- ◆ 100% Duty Cycle During Low-Dropout Operation
- ◆ Output Short-Circuit Protection
- ◆ 16-Pin QSOP Package

## Ordering Information

PART	TEMP RANGE	PIN-PACKAGE
MAX1742EEE	-40°C to +85°C	16 QSOP
MAX1842EEE	-40°C to +85°C	16 QSOP

## Typical Configuration

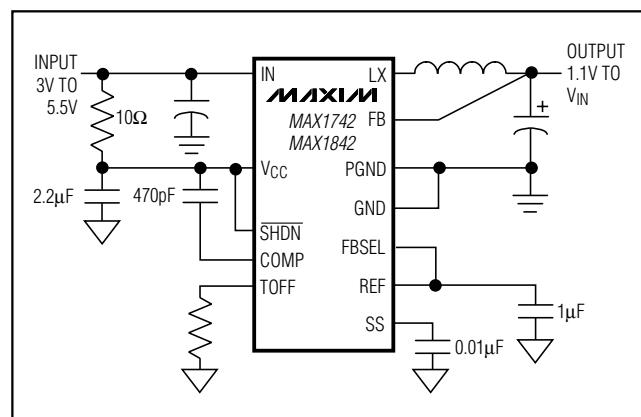
**MAXIM**

Maxim Integrated Products 1

For pricing, delivery, and ordering information, please contact Maxim/Dallas Direct! at 1-888-629-4642, or visit Maxim's website at [www.maxim-ic.com](http://www.maxim-ic.com).

MAX1742/MAX1842

# 1A/2.7A, 1MHz, Step-Down Regulators with Synchronous Rectification and Internal Switches

## ABSOLUTE MAXIMUM RATINGS

V <sub>CC</sub> , IN to GND .....	-0.3V to +6V	Continuous Power Dissipation (T <sub>A</sub> = +70°C) SSOP (derate 16.7mW/°C above +70°C; part mounted on 1 in. <sup>2</sup> of 1oz. copper).....	1W
IN to V <sub>CC</sub> .....	±0.3V		
GND to PGND.....	±0.3V	Operating Temperature Range .....	-40°C to +85°C
All Other Pins to GND.....	-0.3V to (V <sub>CC</sub> + 0.3V)	Storage Temperature Range .....	-65°C to +150°C
LX Current (Note 1).....	±4.7A	Lead Temperature (soldering, 10s).....	+300°C
REF Short Circuit to GND Duration .....	Continuous		
ESD Protection .....	±2kV		

**Note 1:** LX has internal clamp diodes to PGND and IN. Applications that forward-bias these diodes should take care not to exceed the IC's package power dissipation limits.

Stresses beyond those listed under "Absolute Maximum Ratings" may cause permanent damage to the device. These are stress ratings only, and functional operation of the device at these or any other conditions beyond those indicated in the operational sections of the specifications is not implied. Exposure to absolute maximum rating conditions for extended periods may affect device reliability.

## ELECTRICAL CHARACTERISTICS

(V<sub>IN</sub> = V<sub>CC</sub> = 3.3V, FBSEL = GND, T<sub>A</sub> = 0°C to +85°C, unless otherwise noted. Typical values are at T<sub>A</sub> = +25°C.)

PARAMETER	SYMBOL	CONDITIONS		MIN	TYP	MAX	UNITS	
Input Voltage	V <sub>IN</sub> , V <sub>CC</sub>			3.0		5.5	V	
Preset Output Voltage	V <sub>OUT</sub>	V <sub>IN</sub> = 3V to 5.5V, I <sub>LOAD</sub> = 0 to 1A for MAX1742, I <sub>LOAD</sub> = 0 to 2.5A for MAX1842, V <sub>FB</sub> = V <sub>OUT</sub>	FBSEL = V <sub>CC</sub>	T <sub>A</sub> = +25°C to +85°C	2.500	2.525	2.550	V
				T <sub>A</sub> = +0°C to +85°C	2.487	2.525	2.563	
			FBSEL = unconnected	T <sub>A</sub> = +25°C to +85°C	1.500	1.515	1.530	
				T <sub>A</sub> = +0°C to +85°C	1.492	1.515	1.538	
			FBSEL = REF	T <sub>A</sub> = +25°C to +85°C	1.800	1.818	1.836	
				T <sub>A</sub> = +0°C to +85°C	1.791	1.818	1.845	
			FBSEL = GND	T <sub>A</sub> = +25°C to +85°C	1.089	1.100	1.111	
				T <sub>A</sub> = +0°C to +85°C	1.084	1.100	1.117	
Adjustable Output Voltage Range		V <sub>IN</sub> = V <sub>CC</sub> = 3V to 5.5V, I <sub>LOAD</sub> = 0, FBSEL = GND		V <sub>REF</sub>		V <sub>IN</sub>	V	
AC Load Regulation Error					2		%	
DC Load Regulation Error					0.4		%	
Dropout Voltage	V <sub>DO</sub>	V <sub>IN</sub> = V <sub>CC</sub> = 3V, I <sub>LOAD</sub> = 1A				250	mV	
Reference Voltage	V <sub>REF</sub>	T <sub>A</sub> = +25°C to +85°C		1.089	1.100	1.111	V	
		T <sub>A</sub> = +0°C to +85°C		1.084	1.100	1.117		
Reference Load Regulation	ΔV <sub>REF</sub>	I <sub>REF</sub> = -1μA to +10μA			0.5	2	mV	
PMOS Switch On-Resistance	R <sub>ON, P</sub>	I <sub>LX</sub> = 0.5A	V <sub>IN</sub> = 4.5V		90	200	mΩ	
			V <sub>IN</sub> = 3V		110	250		
NMOS Switch On-Resistance	R <sub>ON, N</sub>	I <sub>LX</sub> = 0.5A	V <sub>IN</sub> = 4.5V		70	150		
			V <sub>IN</sub> = 3V		80	200		

# 1A/2.7A, 1MHz, Step-Down Regulators with Synchronous Rectification and Internal Switches

MAX1742/MAX1842

## ELECTRICAL CHARACTERISTICS (continued)

( $V_{IN} = V_{CC} = 3.3V$ ,  $FBSEL = GND$ ,  $T_A = 0^{\circ}C$  to  $+85^{\circ}C$ , unless otherwise noted. Typical values are at  $T_A = +25^{\circ}C$ .)

PARAMETER	SYMBOL	CONDITIONS	MIN	TYP	MAX	UNITS
Current-Limit Threshold	$I_{LIMIT}$	MAX1742	1.3	1.5	1.7	A
		MAX1842	3.1	3.6	4.1	
RMS LX Output Current					3.1	A
Idle Mode Current Threshold	$I_{IM}$	MAX1742	0.1	0.3	0.5	A
		MAX1842	0.3	0.6	0.9	
Switching Frequency	f	(Note 2)			1	MHz
No-Load Supply Current	$I_{IN} + I_{CC}$	$V_{FB} = 1.2V$		350	600	$\mu A$
Shutdown Supply Current	$I_{CC}(SHDN)$	$SHDN = GND$		<1	5	$\mu A$
PMOS Switch Off-Leakage Current	$I_{IN}$	$\overline{SHDN} = GND$			15	$\mu A$
Thermal Shutdown Threshold	$T_{SHDN}$	Hysteresis = $15^{\circ}C$		160		$^{\circ}C$
Undervoltage Lockout Threshold	$V_{UVLO}$	$V_{IN}$ falling, hysteresis = 90mV	2.5	2.6	2.7	V
FB Input Bias Current	$I_{FB}$	$V_{FB} = 1.2V$	0	60	250	nA
Off-Time Default Period	$t_{OFF}$	$R_{TOFF} = 110k\Omega$	0.9	1.00	1.1	$\mu s$
		$R_{TOFF} = 30.1k\Omega$	0.24	0.30	0.37	
		$R_{TOFF} = 499k\Omega$	3.8	4.5	5.2	
Off-Time Startup Period	$t_{OFF}$	$FB = GND$		$4 \times t_{OFF}$		$\mu s$
On-Time Period	$t_{ON}$	(Note 2)	0.4			$\mu s$
SS Source Current	$I_{SS}$		4	5	6	$\mu A$
SS Sink Current	$I_{SS}$	$V_{SS} = 1V$	100			$\mu A$
$\overline{SHDN}$ Input Current	$I_{\overline{SHDN}}$	$V_{\overline{SHDN}} = 0$ to $V_{CC}$	-1		1	$\mu A$
$\overline{SHDN}$ Input Low Threshold	$V_{IL}$				0.8	V
$\overline{SHDN}$ Input High Threshold	$V_{IH}$		2.0			V
FBSEL Input Current			-4		+4	$\mu A$
FBSEL Logic Thresholds		$FBSEL = GND$			0.2	V
		$FBSEL = REF$	0.9		1.3	
		$FBSEL = \text{unconnected}$	$0.7 \times V_{CC}$ - 0.2	$0.7 \times V_{CC}$ +0.2		
		$FBSEL = V_{CC}$	$V_{CC}$ - 0.2			

# 1A/2.7A, 1MHz, Step-Down Regulators with Synchronous Rectification and Internal Switches

## ELECTRICAL CHARACTERISTICS

( $V_{IN} = V_{CC} = 3.3V$ , FBSEL = GND,  $T_A = -40^{\circ}C$  to  $+85^{\circ}C$ , unless otherwise noted. Typical values are at  $T_A = +25^{\circ}C$ .) (Note 3)

PARAMETER	SYMBOL	CONDITIONS		MIN	MAX	UNITS
Input Voltage	$V_{IN}$			3.0	5.5	V
Preset Output Voltage	$V_{OUT}$	$I_{LOAD} = 0$ to 1A for MAX1742, $I_{LOAD} = 0$ to 2.5A for MAX1842, $V_{FB} = V_{OUT}$	$V_{IN} = 3V$ to 5.5V, FBSEL = $V_{CC}$	2.475	2.575	V
			FBSEL = unconnected	1.485	1.545	
			FBSEL = REF	1.782	1.854	
			FBSEL = GND	1.078	1.122	
Adjustable Output Voltage Range		$V_{IN} = V_{CC} = 3V$ to 5.5V, $I_{LOAD} = 0$ , FBSEL = GND		$V_{REF}$	$V_{IN}$	V
Reference Voltage	$V_{REF}$			1.078	1.122	V
PMOS Switch On-Resistance	$R_{ON, P}$	$I_{LX} = 0.5A$	$V_{IN} = 4.5V$		200	m $\Omega$
			$V_{IN} = 3V$		250	
NMOS Switch On-Resistance	$R_{ON, N}$	$I_{LX} = 0.5A$	$V_{IN} = 4.5V$		150	
			$V_{IN} = 3V$		200	
Current-Limit Threshold	$I_{LIMIT}$	MAX1742		1.2	1.8	A
		MAX1842		2.9	4.3	
Idle Mode Current Threshold	$I_{IM}$	MAX1742		0.05	0.55	
		MAX1842		0.2	1.0	
No-Load Supply Current	$I_{IN} + I_{CC}$	$V_{FB} = 1.2V$			600	$\mu A$
FB Input Bias Current	$I_{FB}$	$V_{FB} = 1.2V$		0	300	nA
Off-Time Default Period	$t_{OFF}$	$R_{TOFF} = 110k\Omega$		0.85	1.15	$\mu s$

**Note 2:** Recommended operating frequency, not production tested.

**Note 3:** Specifications from  $0^{\circ}C$  to  $-40^{\circ}C$  are guaranteed by design, not production tested.

# 1A/2.7A, 1MHz, Step-Down Regulators with Synchronous Rectification and Internal Switches

## Typical Operating Characteristics

(Circuit of Figure 1,  $T_A = +25^\circ\text{C}$ , unless otherwise noted.)

MAX1742/MAX1842

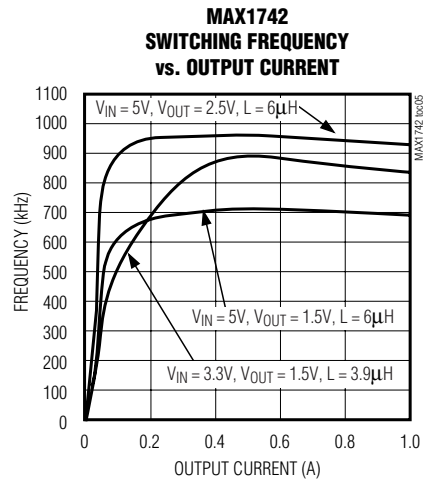
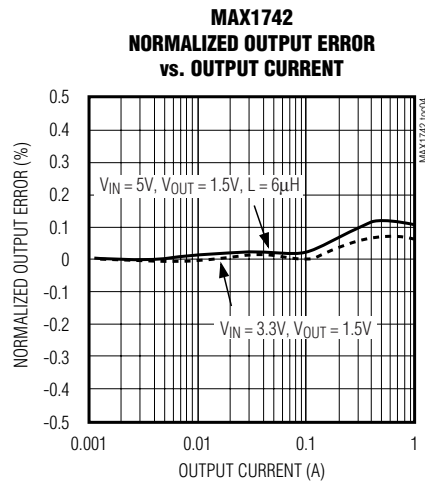
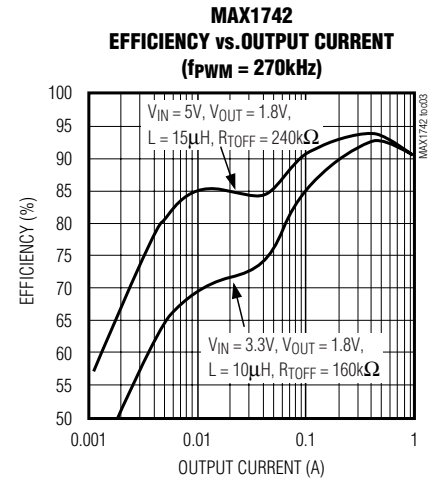
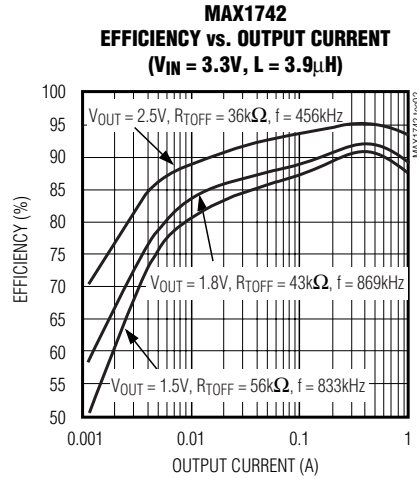
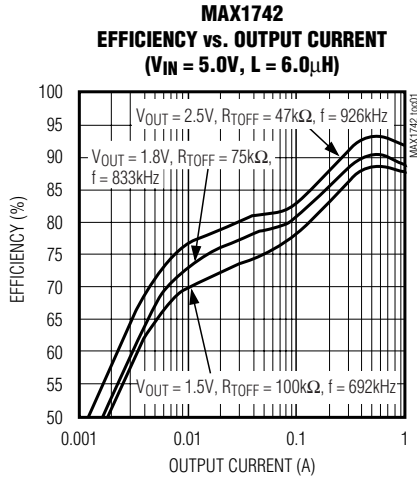

# 1A/2.7A, 1MHz, Step-Down Regulators with Synchronous Rectification and Internal Switches

## Typical Operating Characteristics (continued)

(Circuit of Figure 1,  $T_A = +25^\circ\text{C}$ , unless otherwise noted.)

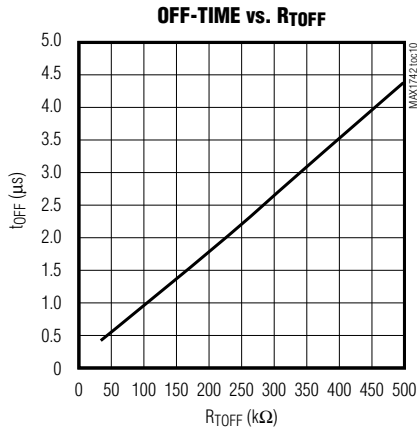
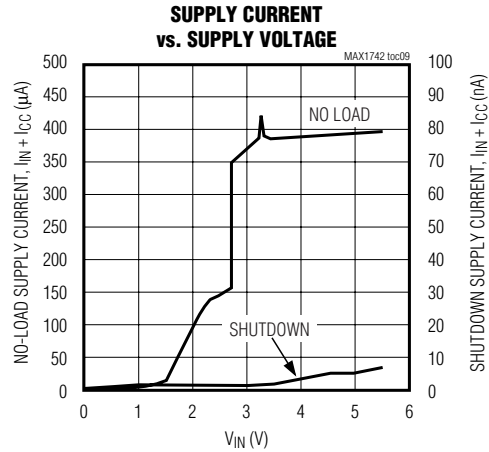
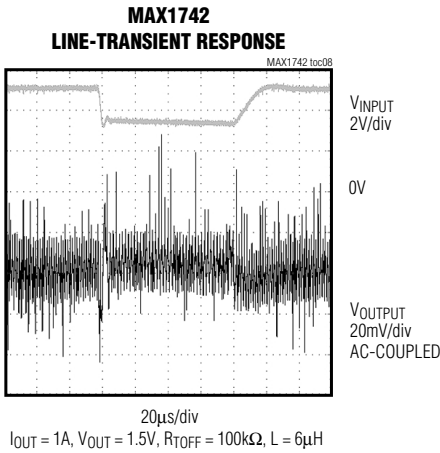
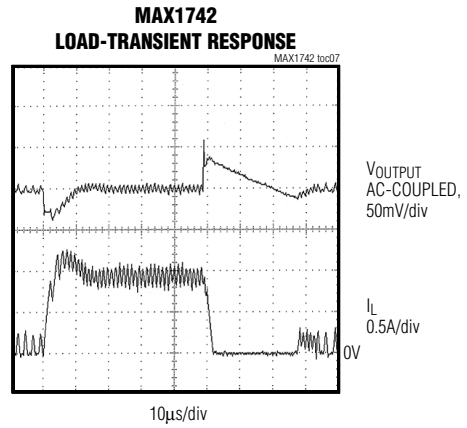
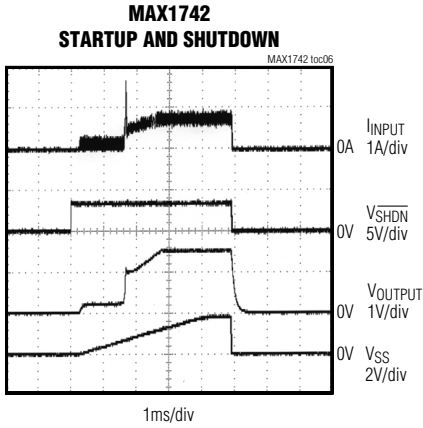

# 1A/2.7A, 1MHz, Step-Down Regulators with Synchronous Rectification and Internal Switches

MAX1742/MAX1842

## Typical Operating Characteristics (continued)

(Circuit of Figure 1,  $T_A = +25^\circ\text{C}$ , unless otherwise noted.)

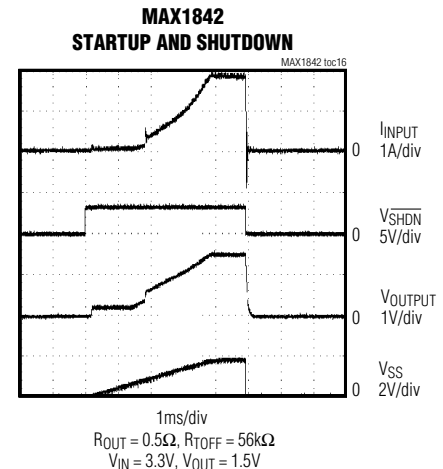
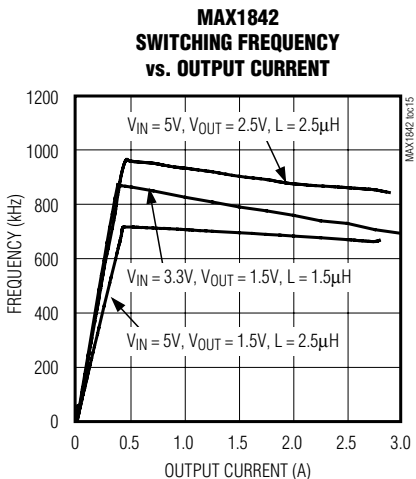
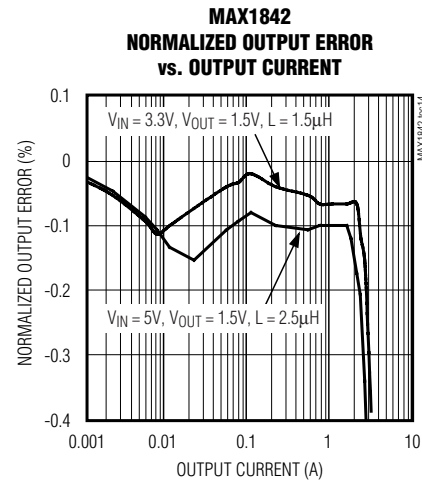
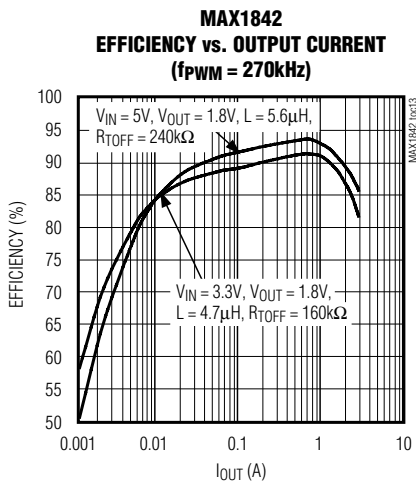
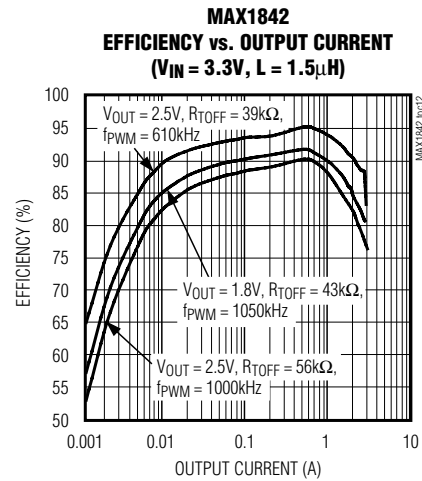
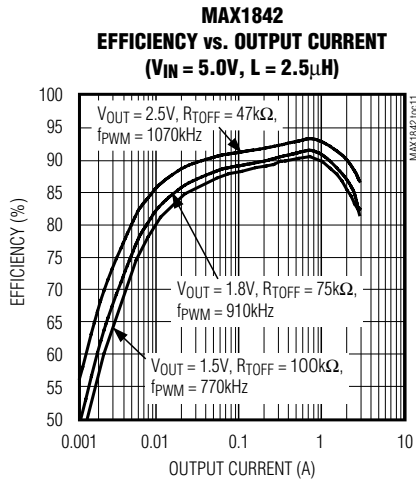

# 1A/2.7A, 1MHz, Step-Down Regulators with Synchronous Rectification and Internal Switches

## Typical Operating Characteristics (continued)

(Circuit of Figure 1,  $T_A = +25^\circ\text{C}$ , unless otherwise noted.)

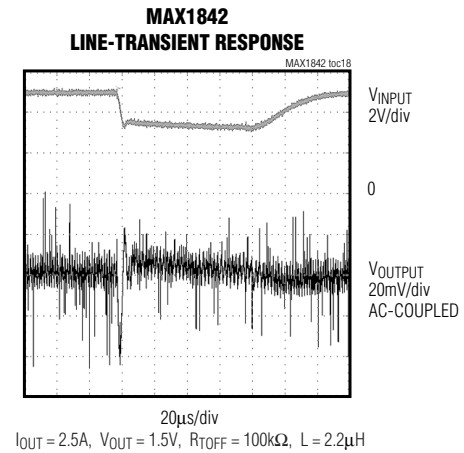
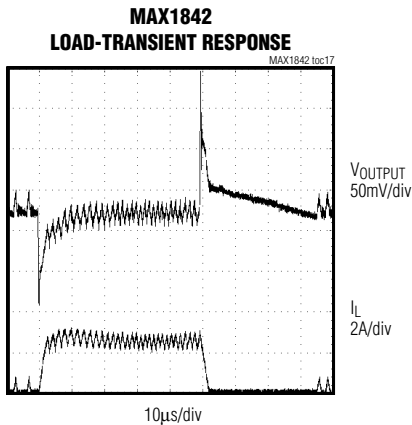

## Pin Description

PIN	NAME	FUNCTION
1	$\overline{\text{SHDN}}$	Shutdown Control Input. Drive $\overline{\text{SHDN}}$ low to disable the reference, control circuitry, and internal MOSFETs. Drive high or connect to $V_{\text{CC}}$ for normal operation.
2, 4	IN	Supply Voltage Input—for the internal PMOS power switch.
3, 14, 16	LX	Connection for the drains of the PMOS power switch and NMOS synchronous-rectifier switch. Connect the inductor from this node to the output filter capacitor and load.
5	SS	Soft-Start. Connect a capacitor from SS to GND to limit inrush current during startup.
6	COMP	Integrator Compensation. Connect a capacitor from COMP to $V_{\text{CC}}$ for integrator compensation. See <i>Integrator Amplifier</i> section.
7	TOFF	Off-Time Select Input. Sets the PMOS power switch off-time during constant-off-time operation. Connect a resistor from TOFF to GND to adjust the PMOS switch off-time.
8	FB	Feedback Input—for both preset-output and adjustable-output operating modes. Connect directly to output for fixed-voltage operation or to a resistive divider for adjustable operating modes.
9	GND	Analog Ground
10	REF	Reference Output. Bypass REF to GND with a $1\mu\text{F}$ capacitor.
11	FBSEL	Feedback Select Input. Selects output voltage. See Table 3 for programming instructions.
12	$V_{\text{CC}}$	Analog Supply Voltage Input. Supplies internal analog circuitry. Bypass $V_{\text{CC}}$ with a $10\Omega$ and $2.2\mu\text{F}$ low-pass filter. See Figure 1.
13, 15	PGND	Power Ground. Internally connected to the internal NMOS synchronous-rectifier switch.



# 1A/2.7A, 1MHz, Step-Down Regulators with Synchronous Rectification and Internal Switches

## Detailed Description

The MAX1742/MAX1842 synchronous, current-mode, constant-off-time, PWM DC-DC converters step down input voltages of 3V to 5.5V to a preset output voltage of 2.5V, 1.8V, or 1.5V, or to an adjustable output voltage from 1.1V to  $V_{IN}$ . Both devices deliver up to 1A of continuous output current; the MAX1842 delivers bursts of output current up to 2.7A (see the *Extended Current Limit* section). Internal switches composed of a  $0.09\Omega$  PMOS power switch and a  $0.07\Omega$  NMOS synchronous rectifier switch improve efficiency, reduce component count, and eliminate the need for an external Schottky diode.

The MAX1742/MAX1842 optimize efficiency by operating in constant-off-time mode under heavy loads and in Maxim's proprietary Idle Mode under light loads. A single resistor-programmable constant-off-time control sets switching frequencies up to 1MHz, allowing the user to optimize performance trade-offs in efficiency, switching noise, component size, and cost. Under low-dropout conditions, the device operates in a 100% duty-cycle mode, where the PMOS switch remains continuously on. Idle Mode enhances light-load efficiency by skipping cycles, thus reducing transition and gate-charge losses.

When power is drawn from a regulated supply, constant-off-time PWM architecture essentially provides constant-frequency operation. This architecture has the inherent advantage of quick response to line and load transients.

The MAX1742/MAX1842s' current-mode, constant-off-time PWM architecture regulates the output voltage by changing the PMOS switch on-time relative to the constant off-time. Increasing the on-time increases the peak inductor current and the amount of energy transferred to the load per pulse.

### Modes of Operation

The current through the PMOS switch determines the mode of operation: constant-off-time mode (for load currents greater than half the Idle Mode threshold), or Idle Mode (for load currents less than half the Idle Mode threshold). Current sense is achieved through a proprietary architecture that eliminates current-sensing  $I^2R$  losses.

### Constant-Off-Time Mode

Constant-off-time operation occurs when the current through the PMOS switch is greater than the Idle Mode threshold current (which corresponds to a load current of half the Idle Mode threshold). In this mode, the regulation comparator turns the PMOS switch on at the end of each off-time, keeping the device in continuous-conduction mode. The PMOS switch remains on until the

output is in regulation or the current limit is reached. When the PMOS switch turns off, it remains off for the programmed off-time ( $t_{OFF}$ ). To control the current under short-circuit conditions, the PMOS switch remains off for approximately  $4 \times t_{OFF}$  when  $V_{OUT} < V_{OUT(NOM)} / 4$ .

### Idle Mode

Under light loads, the devices improve efficiency by switching to a pulse-skipping Idle Mode. Idle Mode operation occurs when the current through the PMOS switch is less than the Idle Mode threshold current. Idle Mode forces the PMOS to remain on until the current through the switch reaches the Idle Mode threshold, thus minimizing the unnecessary switching that degrades efficiency under light loads. In Idle Mode, the device operates in discontinuous conduction. Current-sense circuitry monitors the current through the NMOS synchronous switch, turning it off before the current reverses. This prevents current from being pulled from the output filter through the inductor and NMOS switch to ground. As the device switches between operating modes, no major shift in circuit behavior occurs.

### 100% Duty-Cycle Operation

When the input voltage drops near the output voltage, the duty cycle increases until the PMOS MOSFET is on continuously. The dropout voltage in 100% duty cycle is the output current multiplied by the on-resistance of the internal PMOS switch and parasitic resistance in the inductor. The PMOS switch remains on continuously as long as the current limit is not reached.

### Shutdown

Drive  $\overline{SHDN}$  to a logic-level low to place the MAX1742/MAX1842 in low-power shutdown mode and reduce supply current to less than  $1\mu A$ . In shutdown, all circuitry and internal MOSFETs turn off, and the LX node becomes high impedance. Drive  $\overline{SHDN}$  to a logic-level high or connect to  $V_{CC}$  for normal operation.

### Summing Comparator

Three signals are added together at the input of the summing comparator (Figure 2): an output voltage error signal relative to the reference voltage, an integrated output voltage error correction signal, and the sensed PMOS switch current. The integrated error signal is provided by a transconductance amplifier with an external capacitor at COMP. This integrator provides high DC accuracy without the need for a high-gain amplifier. Connecting a capacitor at COMP modifies the overall loop response (see the *Integrator Amplifier* section).

# 1A/2.7A, 1MHz, Step-Down Regulators with Synchronous Rectification and Internal Switches

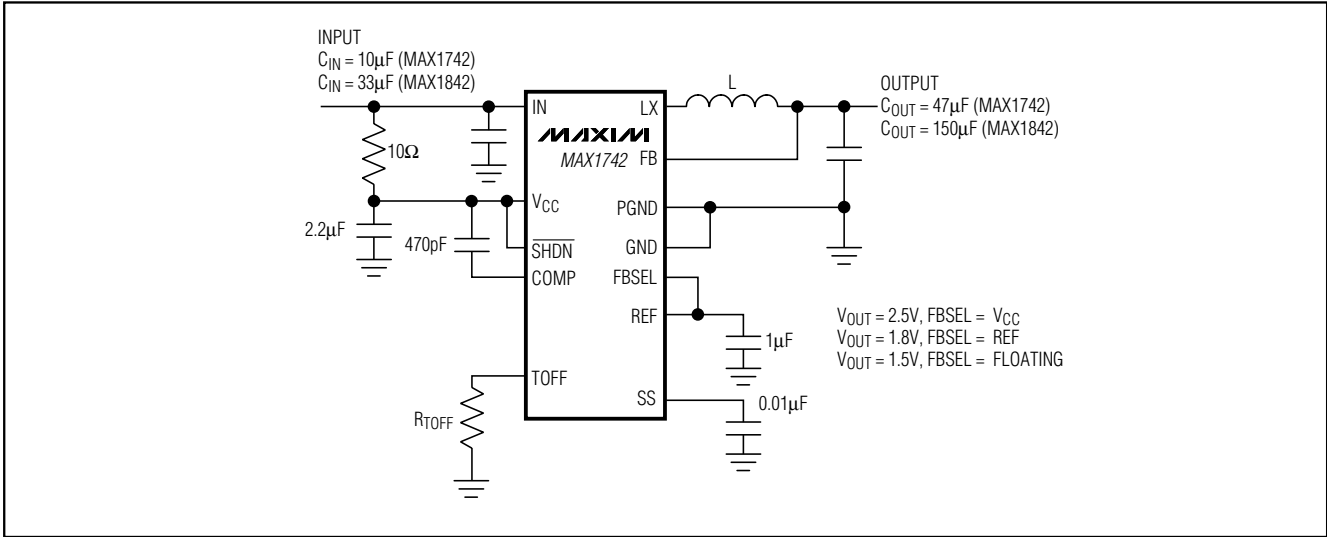

Figure 1. Typical Circuit

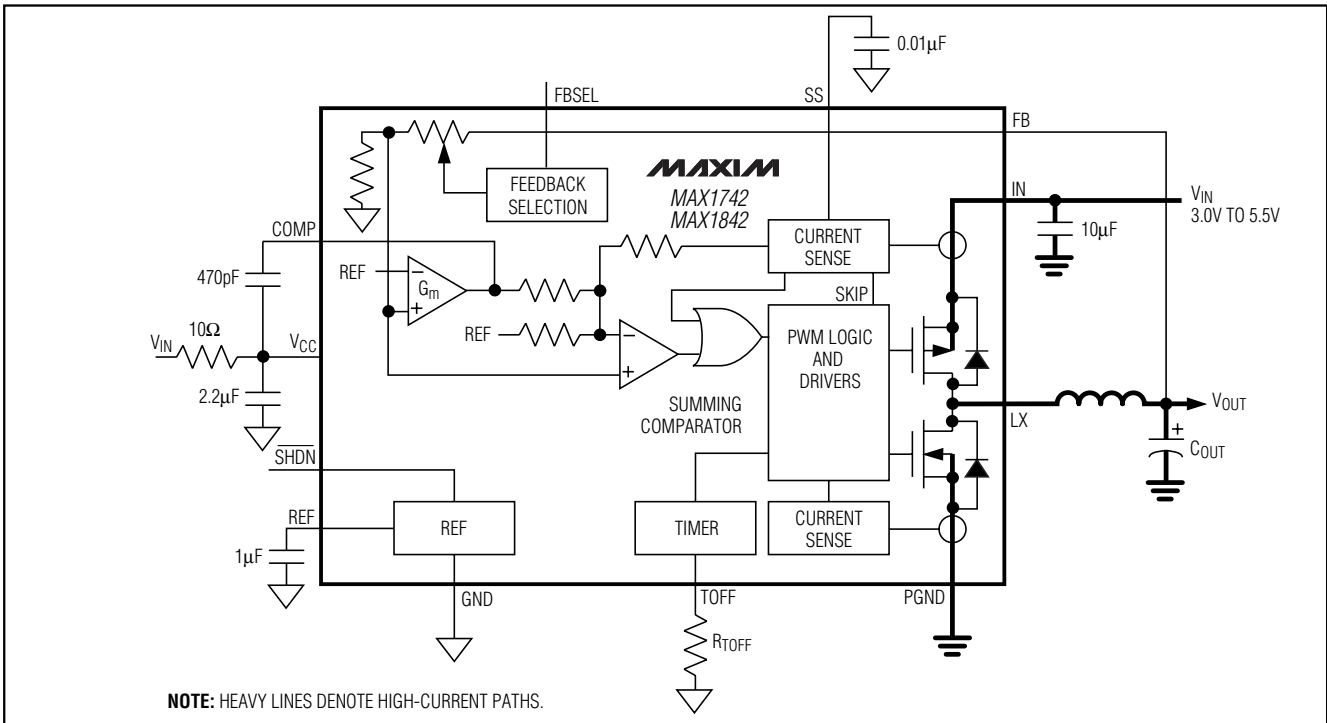

Figure 2. Functional Diagram

## Synchronous Rectification

In a step-down regulator without synchronous rectification, an external Schottky diode provides a path for current to flow when the inductor is discharging. Replacing the Schottky diode with a low-resistance NMOS syn-

chronous switch reduces conduction losses and improves efficiency.

The NMOS synchronous-rectifier switch turns on following a short delay after the PMOS power switch turns off, thus preventing cross conduction or “shoot through.” In

# 1A/2.7A, 1MHz, Step-Down Regulators with Synchronous Rectification and Internal Switches

MAX1742/MAX1842

constant-off-time mode, the synchronous-rectifier switch turns off just prior to the PMOS power switch turning on. While both switches are off, inductor current flows through the internal body diode of the NMOS switch. The internal body diode's forward voltage is relatively high.

## Thermal Resistance

Junction-to-ambient thermal resistance,  $\theta_{JA}$ , is highly dependent on the amount of copper area immediately surrounding the IC leads. The MAX1742 evaluation kit has 0.5in<sup>2</sup> of copper area and a thermal resistance of 80°C/W with no forced airflow. Airflow over the board significantly reduces the junction-to-ambient thermal resistance. For heatsinking purposes, evenly distribute the copper area connected at the IC among the high-current pins.

## Power Dissipation

Power dissipation in the MAX1742/MAX1842 is dominated by conduction losses in the two internal power switches. Power dissipation due to supply current in the control section and average current used to charge and discharge the gate capacitance of the internal switches (i.e., switching losses) is approximately:

$$P_{DS} = C \times V_{IN}^2 \times f_{PWM}$$

where  $C = 2.5nF$  and  $f_{PWM}$  is the switching frequency in PWM mode.

This number is reduced when the switching frequency decreases as the part enters Idle Mode. Combined conduction losses in the two power switches are approximated by:

$$P_D = I_{OUT}^2 \times R_{PMOS}$$

where  $R_{PMOS}$  is the on-resistance of the PMOS switch.

The junction-to-ambient thermal resistance required to dissipate this amount of power is calculated by:

$$\theta_{JA} = (T_{J,MAX} - T_{A,MAX}) / P_{D(TOT)}$$

where:  $\theta_{JA}$  = junction-to-ambient thermal resistance

$T_{J,MAX}$  = maximum junction temperature

$T_{A,MAX}$  = maximum ambient temperature

$P_{D(TOT)}$  = total losses

## Design Procedure

For typical applications, use the recommended component values in Tables 1 or 2. For other applications, take the following steps:

- 1) Select the desired PWM-mode switching frequency; 1MHz is a good starting point. See Figure 3 for maximum operating frequency.

**Table 1. MAX1742 Recommended Component Values (I<sub>OUT</sub> = 1A)**

V <sub>IN</sub> (V)	V <sub>OUT</sub> (V)	f <sub>PWM</sub> (kHz)	L (μH)	R <sub>TOFF</sub> (kΩ)
5	3.3	850	5.6	39
5	2.5	1070	5.6	47
5	1.8	910	5.6	75
5	1.5	770	5.6	100
3.3	2.5	610	3.9	39
3.3	1.8	1050	3.9	43
3.3	1.5	1000	3.9	56

**Table 2. MAX1842 Recommended Component Values (Continuous Output Current = 1A, Burst Output Current = 2.7A)**

V <sub>IN</sub> (V)	V <sub>OUT</sub> (V)	f <sub>PWM</sub> (kHz)	L (μH)	R <sub>TOFF</sub> (kΩ)
5	3.3	800	2.2	39
5	2.5	1180	2.2	47
5	1.8	850	2.2	75
5	1.5	715	2.2	100
3.3	2.5	570	1.5	39
3.3	1.8	985	1.5	43
3.3	1.5	940	1.5	56

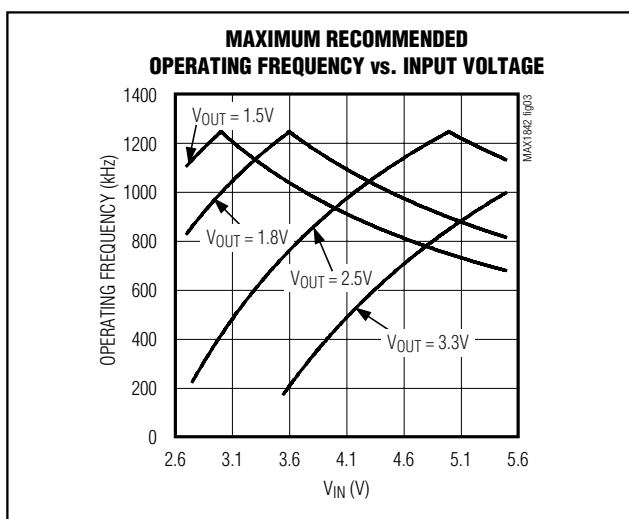

Figure 3. Maximum Recommended Operating Frequency vs. Input Voltage

# 1A/2.7A, 1MHz, Step-Down Regulators with Synchronous Rectification and Internal Switches

Table 3. Output Voltage Programming

PIN		OUTPUT VOLTAGE (V)
FBSEL	FB	
VCC	Output voltage	2.5
Unconnected	Output voltage	1.5
REF	Output voltage	1.8
GND	Resistive divider	Adjustable

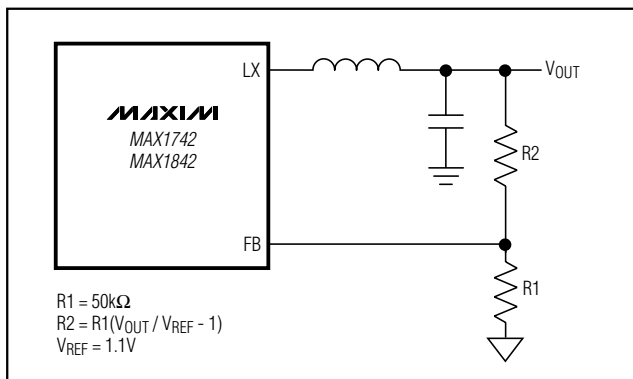

Figure 4. Adjustable Output Voltage

- 2) Select the constant off-time as a function of input voltage, output voltage, and switching frequency.
- 3) Select  $R_{TOFF}$  as a function of off-time.
- 4) Select the inductor as a function of output voltage, off-time, and peak-to-peak inductor current.

### Setting the Output Voltage

The output of the MAX1742/MAX1842 is selectable between one of three preset output voltages: 2.5V, 1.8V, and 1.5V. For a preset output voltage, connect FB to the output voltage and connect FBSEL as indicated in Table 3. For an adjustable output voltage, connect FBSEL to GND and connect FB to a resistive divider between the output voltage and ground (Figure 4). Regulation is maintained for adjustable output voltages when  $V_{FB} = V_{REF}$ . Use  $50k\Omega$  for R1. R2 is given by the equation:

$$R2 = R1 \left( \frac{V_{OUT}}{V_{REF}} - 1 \right)$$

where  $V_{REF}$  is typically 1.1V.

### Programming the Switching Frequency and Off-Time

The MAX1742/MAX1842 features a programmable PWM mode switching frequency, which is set by the input and output voltage and the value of  $R_{TOFF}$ , connected from  $T_{OFF}$  to GND.  $R_{TOFF}$  sets the PMOS power switch off-time in PWM mode. Use the following equation to select the off-time according to your desired switching frequency in PWM mode:

$$t_{OFF} = \frac{(V_{IN} - V_{OUT} - V_{PMOS})}{f_{PWM}(V_{IN} - V_{PMOS} + V_{NMOS})}$$

where:  $t_{OFF}$  = the programmed off-time  
 $V_{IN}$  = the input voltage  
 $V_{OUT}$  = the output voltage  
 $V_{PMOS}$  = the voltage drop across the internal PMOS power switch  
 $V_{NMOS}$  = the voltage drop across the internal NMOS synchronous-rectifier switch  
 $f_{PWM}$  = switching frequency in PWM mode

Select  $R_{TOFF}$  according to the formula:

$$R_{TOFF} = (t_{OFF} - 0.07\mu s) (110k\Omega / 1.00\mu s)$$

Recommended values for  $R_{TOFF}$  range from  $36k\Omega$  to  $430k\Omega$  for off-times of  $0.4\mu s$  to  $4\mu s$ .

### Inductor Selection

The key inductor parameters must be specified: inductor value (L) and peak current ( $I_{PEAK}$ ). The following equation includes a constant, denoted as LIR, which is the ratio of peak-to-peak inductor AC current (ripple current) to maximum DC load current. A higher value of LIR allows smaller inductance but results in higher losses and ripple. A good compromise between size and losses is found at approximately a 25% ripple-current to load-current ratio ( $LIR = 0.25$ ), which corresponds to a peak inductor current 1.125 times the DC load current:

$$L = \frac{V_{OUT} \times t_{OFF}}{I_{OUT} \times LIR}$$

where:  $I_{OUT}$  = maximum DC load current  
LIR = ratio of peak-to-peak AC inductor current to DC load current, typically 0.25

# 1A/2.7A, 1MHz, Step-Down Regulators with Synchronous Rectification and Internal Switches

The peak inductor current at full load is  $1.125 \times I_{OUT}$  if the above equation is used; otherwise, the peak current is calculated by:

$$I_{PEAK} = I_{OUT} + \frac{V_{OUT} \times t_{OFF}}{2 \times L}$$

Choose an inductor with a saturation current at least as high as the peak inductor current. The inductor you select should exhibit low losses at your chosen operating frequency.

## Capacitor Selection

The input filter capacitor reduces peak currents and noise at the voltage source. Use a low-ESR and low-ESL capacitor located no further than 5mm from IN. Select the input capacitor according to the RMS input ripple-current requirements and voltage rating:

$$I_{RIPPLE} = I_{LOAD} \frac{\sqrt{V_{OUT}(V_{IN} - V_{OUT})}}{V_{IN}}$$

where  $I_{RIPPLE}$  = input RMS current ripple.

The output filter capacitor affects the output voltage ripple, output load-transient response, and feedback loop stability. For stable operation, the MAX1742/MAX1842 requires a minimum output ripple voltage of  $V_{RIPPLE} \geq 1\% \times V_{OUT}$ .

The minimum ESR of the output capacitor should be:

$$ESR > 1\% \times \frac{L}{t_{OFF}}$$

Stable operation requires the correct output filter capacitor. When choosing the output capacitor, ensure that:

$$C_{OUT} \geq \frac{t_{OFF}}{V_{OUT}} \quad 33\mu FV/\mu s \text{ for the MAX1742}$$

$$C_{OUT} \geq \frac{t_{OFF}}{V_{OUT}} \quad 79\mu FV/\mu s \text{ for the MAX1842}$$

## Integrator Amplifier

An internal transconductance amplifier fine tunes the output DC accuracy. A capacitor,  $C_{COMP}$ , from COMP to VCC compensates the transconductance amplifier. For stability, choose  $C_{COMP} = 470pF$ .

A large capacitor value maintains a constant average output voltage but slows the loop response to changes in output voltage. A small capacitor value speeds up the loop response to changes in output voltage but

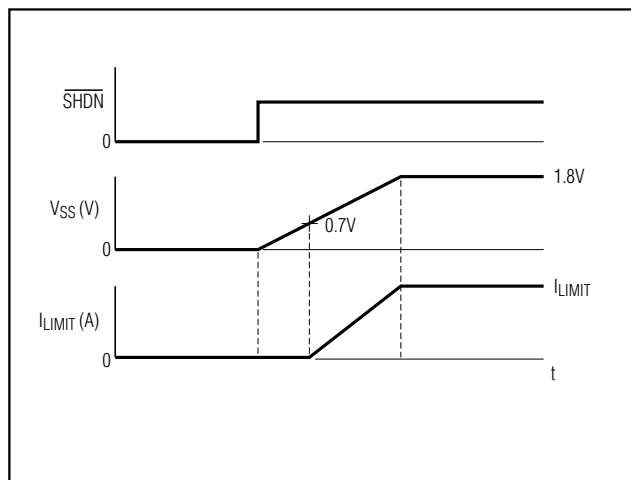

Figure 5. Soft-Start Current Limit over Time

decreases stability. Choose the capacitor values that result in optimal performance.

## Soft-Start

Soft-start allows a gradual increase of the internal current limit to reduce input surge currents at startup and at exit from shutdown. A timing capacitor,  $C_{SS}$ , placed from SS to GND sets the rate at which the internal current limit is changed. Upon power-up, when the device comes out of undervoltage lockout (2.6V typ) or after the SHDN pin is pulled high, a  $4\mu A$  constant-current source charges the soft-start capacitor and the voltage on SS increases. When the voltage on SS is less than approximately 0.7V, the current limit is set to zero. As the voltage increases from 0.7V to approximately 1.8V, the current limit is adjusted from 0 to the current-limit threshold (see the *Electrical Characteristics*). The voltage across the soft-start capacitor changes with time according to the equation:

$$V_{SS} = \frac{4\mu A \times t}{C_{SS}}$$

The soft-start current limit varies with the voltage on the soft-start pin, SS, according to the equation:

$$SS I_{LIMIT} = \frac{V_{SS} - 0.7V}{1.1V} \times I_{LIMIT}$$

where  $I_{LIMIT}$  is the current threshold from the *Electrical Characteristics*.

# 1A/2.7A, 1MHz, Step-Down Regulators with Synchronous Rectification and Internal Switches

The constant-current source stops charging once the voltage across the soft-start capacitor reaches 1.8V (Figure 5).

## Extended Current Limit (MAX1842)

For applications requiring occasional short bursts of high output current (up to 2.7A), the MAX1842 provides a higher current-limit threshold. When using the MAX1842, choose external components capable of withstanding its higher peak current limit.

The MAX1842 is capable of delivering large output currents for limited durations, and its thermal characteristics allow it to operate at continuously higher output currents. Figure 6 shows its maximum recommended continuous output current versus ambient temperature. Figure 7 shows the maximum recommended burst current versus the output current duty cycle at high temperatures.

Figure 7 assumes that the output current is a square wave with a 100Hz frequency. The duty cycle is defined as the duration of the burst current divided by the period of the square wave. This figure shows the limitations for continuous bursts of output current.

Note that if the thermal limitations of the MAX1842 are exceeded, it will enter thermal shutdown to prevent destructive failure.

## Frequency Variation with Output Current

The operating frequency of the MAX1742/MAX1842 is determined primarily by  $t_{OFF}$  (set by  $R_{TOFF}$ ),  $V_{IN}$ , and  $V_{OUT}$  as shown in the following formula:

$$f_{PWM} = (V_{IN} - V_{OUT} - V_{PMOS}) / [t_{OFF} (V_{IN} - V_{PMOS} + V_{NMOS})]$$

However, as the output current increases, the voltage drop across the NMOS and PMOS switches increases and the voltage across the inductor decreases. This causes the frequency to drop. The change in frequency can be approximated with the following formula:

$$\Delta f_{PWM} = -I_{OUT} \times R_{PMOS} / (V_{IN} \times t_{OFF})$$

where  $R_{PMOS}$  is the resistance of the internal MOSFETs (90m $\Omega$  typ).

## Circuit Layout and Grounding

Good layout is necessary to achieve the MAX1742/MAX1842s' intended output power level, high efficiency, and low noise. Good layout includes the use of a ground plane, careful component placement, and correct routing of traces using appropriate trace widths. The following points are in order of decreasing importance:

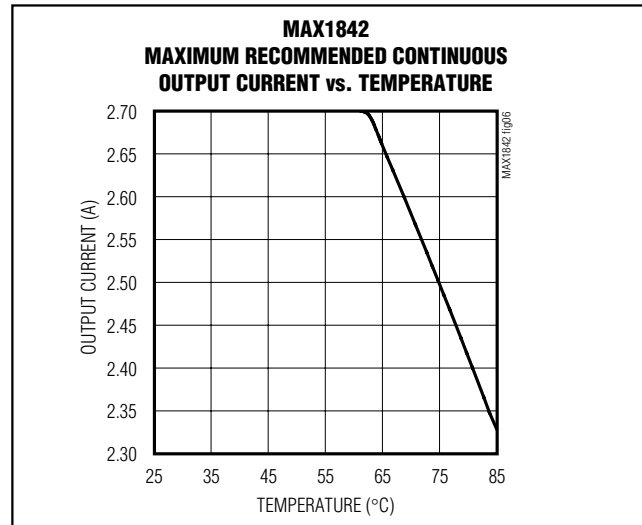

Figure 6. MAX1842 Maximum Recommended Continuous Output Current vs. Temperature

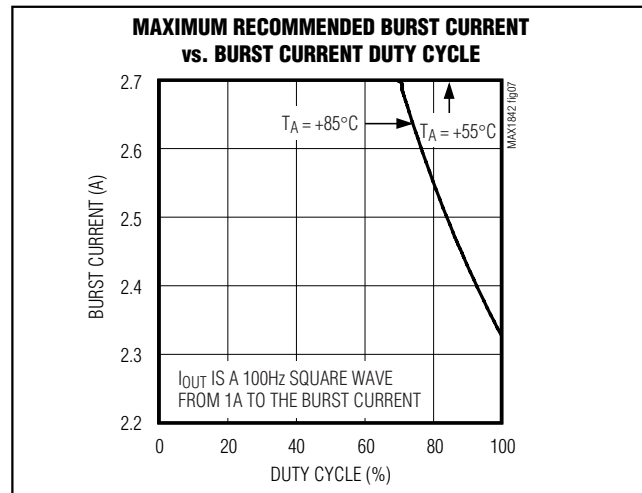

Figure 7. MAX1842 Maximum Recommended Burst Current vs. Burst Current Duty Cycle

- 1) Minimize switched-current and high-current ground loops. Connect the input capacitor's ground, the output capacitor's ground, and PGND. Connect the resulting island to GND at only one point.
- 2) Connect the input filter capacitor less than 5mm away from IN. The connecting copper trace carries large currents and must be at least 1mm wide, preferably 2.5mm.



# 1A/2.7A, 1MHz, Step-Down Regulators with Synchronous Rectification and Internal Switches

- 3) Place the LX node components as close together and as near to the device as possible. This reduces resistive and switching losses as well as noise.
- 4) A ground plane is essential for optimum performance. In most applications, the circuit is located on a multilayer board, and full use of the four or more layers is recommended. Use the top and bottom layers for interconnections and the inner layers for an uninterrupted ground plane. Avoid large AC currents through the ground plane.

## Chip Information

TRANSISTOR COUNT: 3662

## Pin Configuration

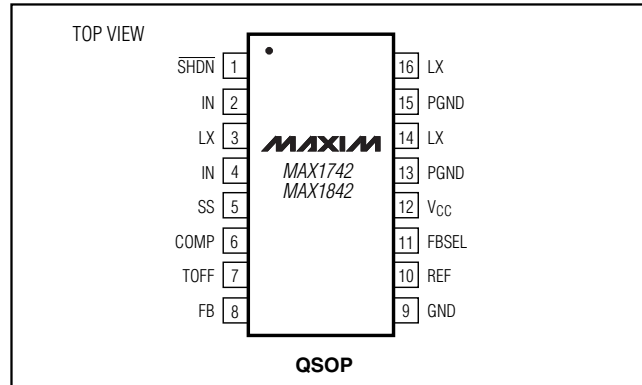

MAX1742/MAX1842

# 1A/2.7A, 1MHz, Step-Down Regulators with Synchronous Rectification and Internal Switches

## Package Information

(The package drawing(s) in this data sheet may not reflect the most current specifications. For the latest package outline information, go to [www.maxim-ic.com/packages](http://www.maxim-ic.com/packages).)

DIM	INCHES		MILLIMETERS	
	MIN	MAX	MIN	MAX
A	.061	.068	1.55	1.73
A1	.004	.0098	0.102	0.249
A2	.055	.061	1.40	1.55
B	.008	.012	0.20	0.31
C	.0075	.0098	0.191	0.249
D	SEE VARIATIONS			
E	.150	.157	3.81	3.99
e	.025 BSC		0.635 BSC	
H	.230	.244	5.84	6.20
h	.010	.016	0.25	0.41
L	.016	.035	0.41	0.89
N	SEE VARIATIONS			
X	SEE VARIATIONS			
Y	.071	.087	1.803	2.209
α	0°	8°	0°	8°

DIM	INCHES		MILLIMETERS		N
	MIN.	MAX.	MIN.	MAX.	
D	.189	.196	4.80	4.98	16 AA
S	.0020	.0070	0.05	0.18	
X	.107	.123	2.72	3.12	
D	.337	.344	8.56	8.74	20 AB
S	.0500	.0550	1.270	1.397	
D	.337	.344	8.56	8.74	24 AC
S	.0250	.0300	0.635	0.762	
D	.386	.393	9.80	9.98	28 AD
S	.0250	.0300	0.635	0.762	
X	.271	.287	6.88	7.29	

**NOTES:**

- D & E DO NOT INCLUDE MOLD FLASH OR PROTRUSIONS.
- MOLD FLASH OR PROTRUSIONS NOT TO EXCEED .006" PER SIDE.
- HEAT SLUG DIMENSIONS X AND Y APPLY ONLY TO 16 AND 28 LEAD POWER-QSOP PACKAGES.
- CONTROLLING DIMENSIONS: INCHES.
- MEETS JEDEC MO137.

MAXIM

PROPRIETARY INFORMATION

TITLE:  
PACKAGE OUTLINE, QSOP, .150", .025" LEAD PITCH

APPROVAL	DOCUMENT CONTROL NO. 21-0055	REV C	1/1
----------	---------------------------------	----------	-----

QSOP-EPS

Maxim cannot assume responsibility for use of any circuitry other than circuitry entirely embodied in a Maxim product. No circuit patent licenses are implied. Maxim reserves the right to change the circuitry and specifications without notice at any time.

16 **Maxim Integrated Products, 120 San Gabriel Drive, Sunnyvale, CA 94086 408-737-7600**