

QTLP670C-T Red

QTL670C-E Orange

QTL670C-AG Yellow-Green

QTL670C-IW White

QTL670C-S Red

QTL670C-O Yellow-Orange

QTL670C-IG True Green

QTL670C-R Red

QTL670C-Y Yellow

QTL670C-IB Blue

PACKAGE DIMENSIONS

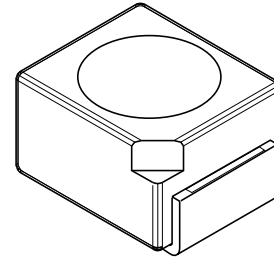
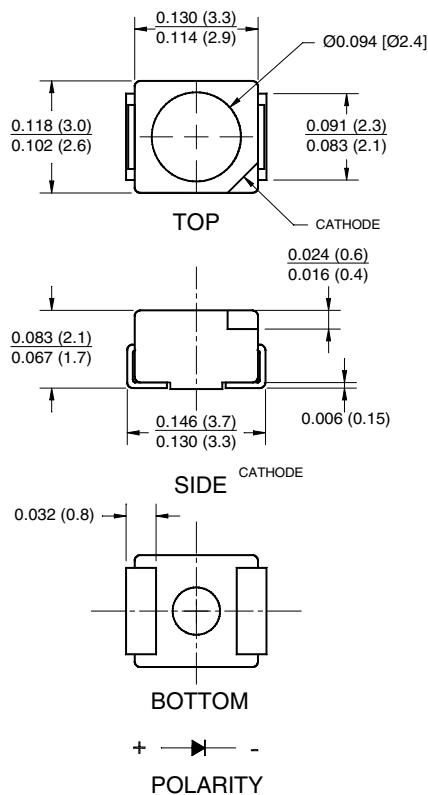

NOTE:

Dimensions for all drawings are in inches (mm).

APPLICATIONS

- Automotive interior lighting
- Status indication for consumer electronics and office equipment

DESCRIPTION

These surface mount LEDs are designed with flat top and sides for the ease of pick-and-place by automatic placement equipment. They are compatible with convective IR and vapor phase reflow soldering. The package size and configuration conform to EIA-535 BAAC standard specification for case size 3528 tantalum capacitor. These LEDs are ideal for backlighting and optical coupling into light pipes.

FEATURES

- AllInGaP technology for -T, -S, -R, -E, -O, -Y and -AG
- InGaN/SiC technology for -IG, -IB and -IW
- Wide viewing angle of 120°
- Water clear optics
- Available in 0.315" (8mm) width tape on 7" (178mm) diameter reel; 2,000 units per reel

SURFACE MOUNT LED LAMP

SUPER BRIGHT PLCC-2

QTLP670C-T Red

QTLP670C-S Red

QTLP670C-R Red

QTLP670C-E Orange

QTLP670C-O Yellow-Orange

QTLP670C-Y Yellow

QTLP670C-AG Yellow-Green

QTLP670C-IG True Green

QTLP670C-IB Blue

QTLP670C-IW White

ABSOLUTE MAXIMUM RATINGS (T_A =25°C Unless otherwise specified)

Parameter	Symbol	QTLP670C							Units
		-T	-S	-R	-E	-O	-Y	-AG	
Continuous Forward Current	I _F	30	30	30	30	30	25	30	mA
Peak Forward Current (f = 1.0 KHz, Duty Factor = 1/10)	I _{FM}	160	160	160	160	160	120	160	mA
Reverse Voltage (I _R = 10 μA)	V _R	5	5	5	5	5	5	5	V
Power Dissipation	P _D	72	72	72	72	72	60	72	mW
Junction Temperature	T _J	100	100	100	100	100	100	100	°C
Thermal Resistance (Junction-Air)	R _{th JA}	500	500	500	500	500	500	500	K/W
Operating Temperature	T _{OPR}	-40 to +95							°C
Storage Temperature	T _{STG}	-40 to +100							°C
Lead Soldering Time	T _{SOL}	260 for 5 sec							°C

ABSOLUTE MAXIMUM RATINGS (T_A =25°C Unless otherwise specified)

Parameter	Symbol	QTLP670C			Units
		-IB	-IG	-IW	
Continuous Forward Current	I _F	30	30	20	mA
Peak Forward Current (f = 1.0 KHz, Duty Factor = 1/10)	I _{FM}	100	100	70	mA
Reverse Voltage (I _R = 10 μA)	V _R	5	5	5	V
Power Dissipation	P _D	120	120	80	mW
Junction Temperature	T _J	125	125	125	°C
Thermal Resistance Junction-Air	R _{th JA}	400	400	400	K/W
Operating Temperature	T _{OPR}	-40 to +95			°C
Storage Temperature	T _{STG}	-40 to +100			°C
Lead Soldering Time	T _{SOL}	260 for 5 sec			°C

SURFACE MOUNT LED LAMP

SUPER BRIGHT PLCC-2

QTLP670C-T Red

QTLP670C-S Red

QTLP670C-R Red

QTLP670C-E Orange

QTLP670C-O Yellow-Orange

QTLP670C-Y Yellow

QTLP670C-AG Yellow-Green

QTLP670C-IG True Green

QTLP670C-IB Blue

QTLP670C-IW White

ELECTRICAL / OPTICAL CHARACTERISTICS (T_A =25°C)

Part Number	Symbol	QTLP670C							Condition
		-T	-S	-R	-E	-O	-Y	-AG	
Luminous Intensity (mcd)	I _v	20	25	25	25	25	25	15	I _F = 20mA
Minimum		45	65	65	65	65	65	30	
Forward Voltage (V)	V _F	2.4	2.4	2.4	2.4	2.4	2.4	2.4	I _F = 20mA
Maximum		2.0	2.0	2.0	2.0	2.0	2.0	2.0	
Wavelength (nm)	λ _P	650	640	630	620	610	590	575	I _F = 20mA
Peak		640	632	624	615	605	589	573	
Dominant	λ _D	20	20	20	18	18	15	20	I _F = 20mA
Spectral Line Half Width (nm)	Δλ	120	120	120	120	120	120	120	I _F = 20mA
Viewing Angle (°)	2Θ _{1/2}								I _F = 20mA

ELECTRICAL / OPTICAL CHARACTERISTICS (T_A =25°C)

Part Number	Symbol	QTLP670C			Condition
		-IB	-IG	-IW	
Luminous Intensity (mcd)	I _v	30	75	100	I _F = 20mA
Minimum		60	115	250	
Forward Voltage (V)	V _F	4.0	4.0	4.0	I _F = 20mA
Maximum		3.5	3.5	3.5	
Wavelength (nm)	λ _P	465	520	—	I _F = 20mA
Peak		470	525	—	
Dominant	λ _D	—	—	x = 0.30, y = 0.31	I _F = 20mA
Chromaticity Coordinate	x,y	25	35	—	I _F = 20mA
Spectral Line Half Width (nm)	Δλ	120	120	120	I _F = 20mA
Viewing Angle (°)	2Θ _{1/2}				I _F = 20mA

QTLP670C-T Red

QTLP670C-S Red

QTLP670C-R Red

QTLP670C-E Orange

QTLP670C-O Yellow-Orange

QTLP670C-Y Yellow

QTLP670C-AG Yellow-Green

QTLP670C-IG True Green

QTLP670C-IB Blue

QTLP670C-IW White

TYPICAL PERFORMANCE CURVES (QTLP670C-T, -S, -R, -E, -O, -Y and -AG)

Fig. 1 Forward Current vs. Forward Voltage

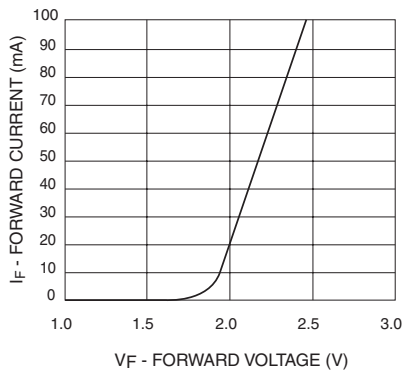

Fig. 2 Relative Luminous Intensity vs. DC Forward Current

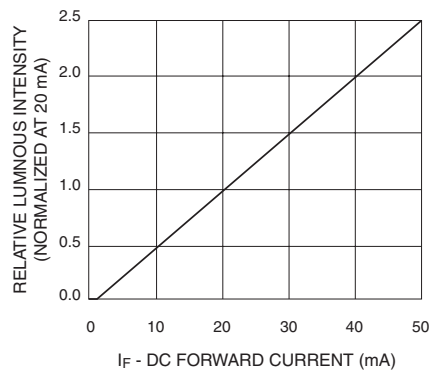

Fig. 3 Relative Intensity vs. Peak Wavelength

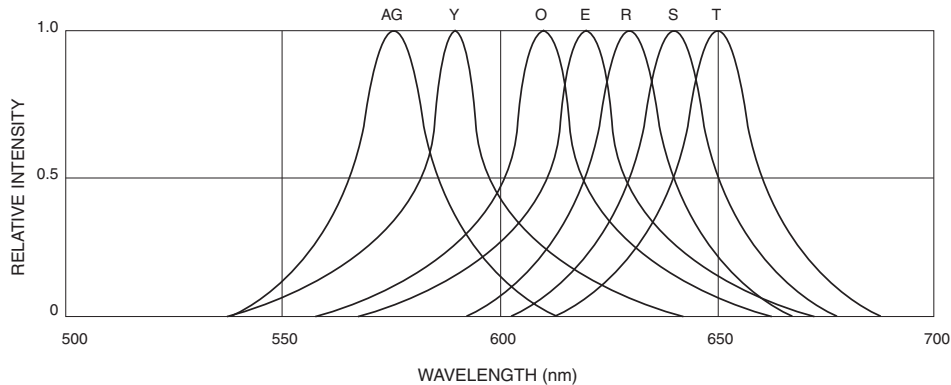

Fig. 4 Radiation Diagram

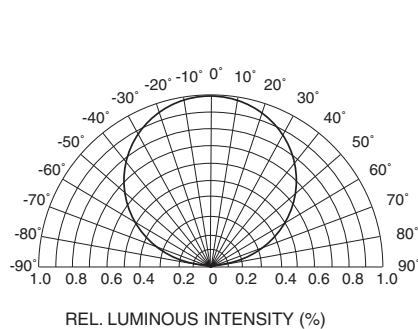
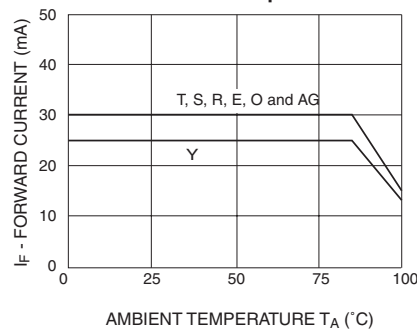

Fig. 5 Maximum Forward Current vs. Ambient Temperature



QTLP670C-T Red

QTLP670C-S Red

QTLP670C-R Red

QTLP670C-E Orange

QTLP670C-O Yellow-Orange

QTLP670C-Y Yellow

QTLP670C-AG Yellow-Green

QTLP670C-IG True Green

QTLP670C-IB Blue

QTLP670C-IW White

TYPICAL PERFORMANCE CURVES (QTLP670C-IG, -IB and -IW)

Fig. 1 Forward Current vs. Forward Voltage

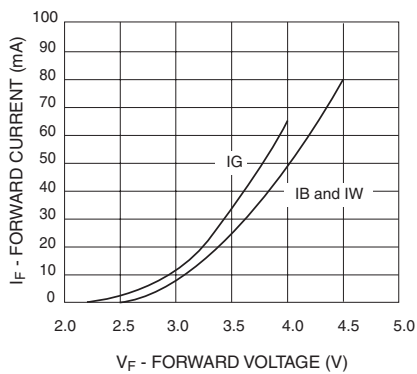

Fig. 2 Relative Luminous Intensity vs. DC Forward Current

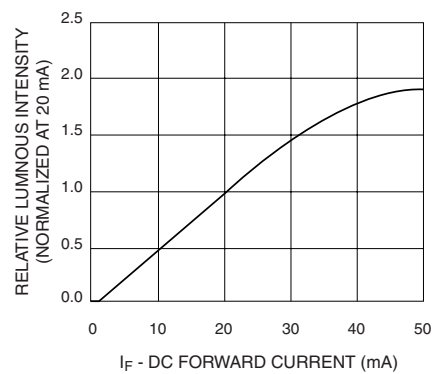

Fig. 3 Relative Intensity vs. Peak Wavelength

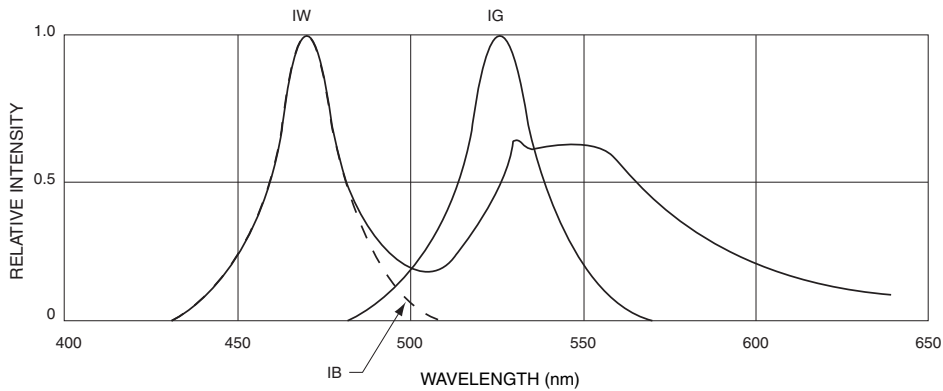

Fig.4 Radiation Diagram

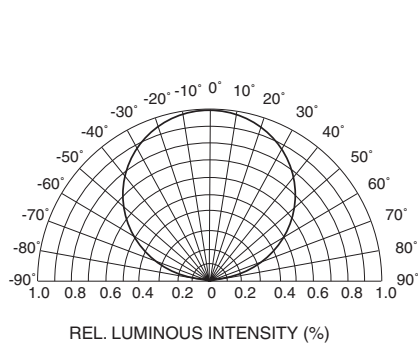
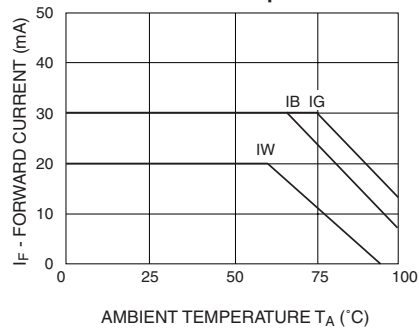

Fig.5 Maximum Forward Current vs. Ambient Temperature



QTLP670C-T Red

QTLP670C-S Red

QTLP670C-R Red

QTLP670C-E Orange

QTLP670C-O Yellow-Orange

QTLP670C-Y Yellow

QTLP670C-AG Yellow-Green

QTLP670C-IG True Green

QTLP670C-IB Blue

QTLP670C-IW White

RECOMMENDED PRINTED CIRCUIT BOARD PATTERN

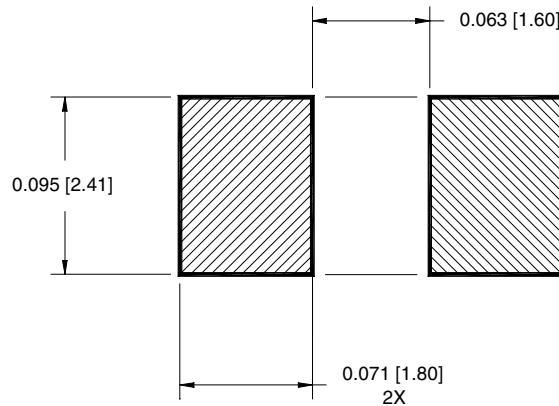

RECOMMENDED IR REFLOW SOLDERING PROFILE

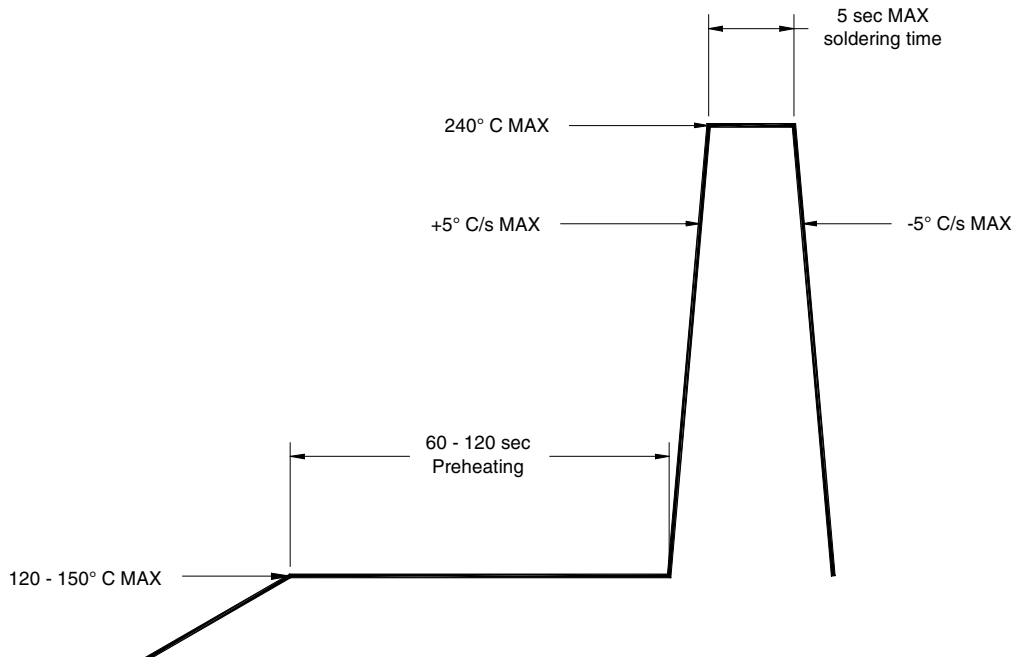

QTLP670C-T Red

QTLP670C-S Red

QTLP670C-R Red

QTLP670C-E Orange

QTLP670C-O Yellow-Orange

QTLP670C-Y Yellow

QTLP670C-AG Yellow-Green

QTLP670C-IG True Green

QTLP670C-IB Blue

QTLP670C-IW White

TAPE AND REEL DIMENSIONS

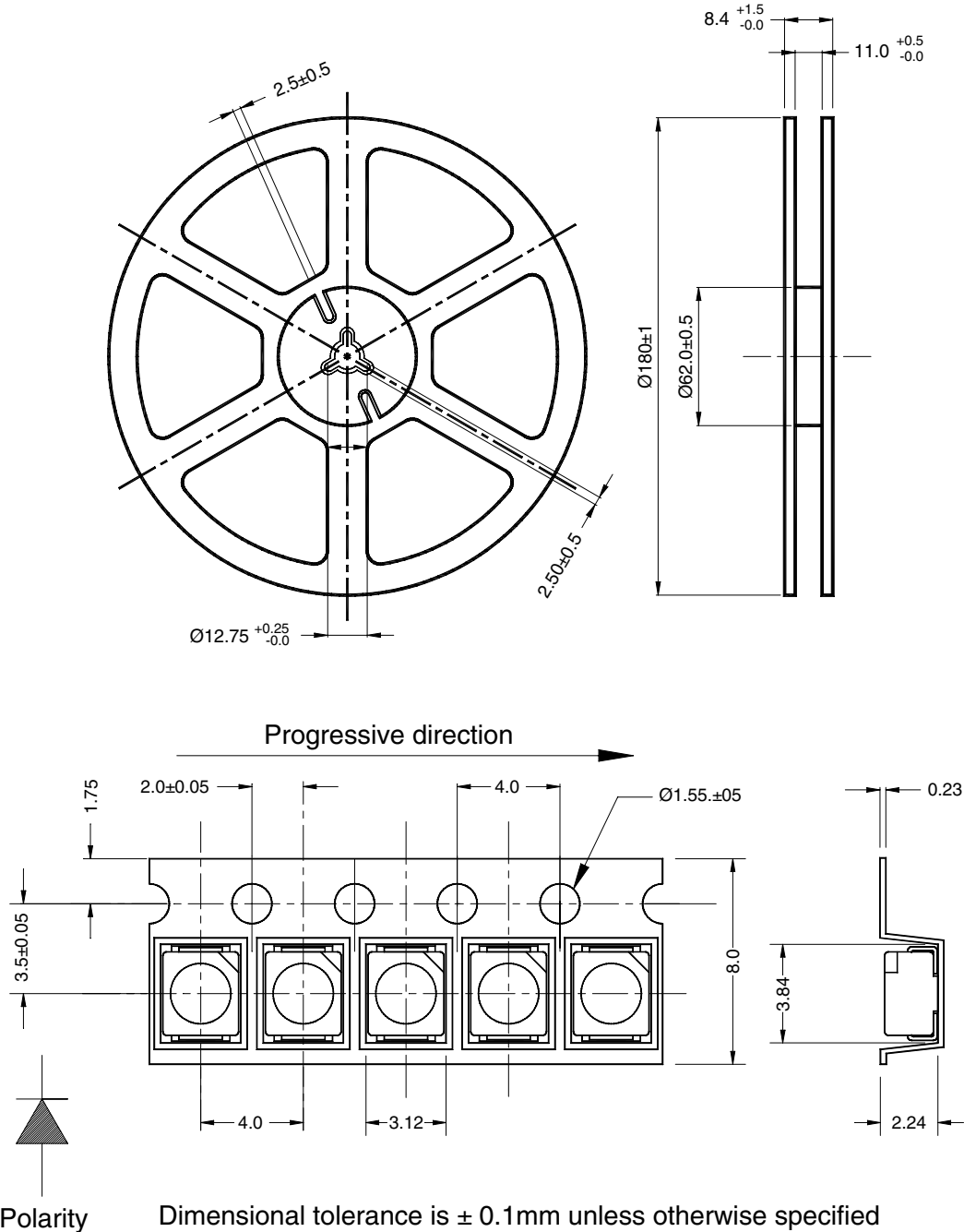

Dimensional tolerance is ± 0.1 mm unless otherwise specified

Angle: ± 0.5

Unit: mm

QTLP670C-T Red

QTLP670C-S Red

QTLP670C-R Red

QTLP670C-E Orange

QTLP670C-O Yellow-Orange

QTLP670C-Y Yellow

QTLP670C-AG Yellow-Green

QTLP670C-IG True Green

QTLP670C-IB Blue

QTLP670C-IW White

DISCLAIMER

FAIRCHILD SEMICONDUCTOR RESERVES THE RIGHT TO MAKE CHANGES WITHOUT FURTHER NOTICE TO ANY PRODUCTS HEREIN TO IMPROVE RELIABILITY, FUNCTION OR DESIGN. FAIRCHILD DOES NOT ASSUME ANY LIABILITY ARISING OUT OF THE APPLICATION OR USE OF ANY PRODUCT OR CIRCUIT DESCRIBED HEREIN; NEITHER DOES IT CONVEY ANY LICENSE UNDER ITS PATENT RIGHTS, NOR THE RIGHTS OF OTHERS.

LIFE SUPPORT POLICY

FAIRCHILD'S PRODUCTS ARE NOT AUTHORIZED FOR USE AS CRITICAL COMPONENTS IN LIFE SUPPORT DEVICES OR SYSTEMS WITHOUT THE EXPRESS WRITTEN APPROVAL OF THE PRESIDENT OF FAIRCHILD SEMICONDUCTOR CORPORATION. As used herein:

1. Life support devices or systems are devices or systems which, (a) are intended for surgical implant into the body, or (b) support or sustain life, and (c) whose failure to perform when properly used in accordance with instructions for use provided in labeling, can be reasonably expected to result in a significant injury of the user.
2. A critical component in any component of a life support device or system whose failure to perform can be reasonably expected to cause the failure of the life support device or system, or to affect its safety or effectiveness.